

QUAD OPERATIONAL AMPLIFIERS

The KA224 series consists of four independent, high gain, internally frequency compensated operational amplifiers which were designed specifically to operate from a single power supply over a wide voltage range.

Operation from split power supplies is also possible so long as the difference between the two supplies is 3 volts to 32 volts.

Application areas include transducer amplifier, DC gain blocks and all the conventional OP amp circuits which now can be easily implemented in single power supply systems.

FEATURES

- Internally frequency compensated for unity gain
- Large DC voltage gain: 100dB
- Wide power supply range: KA224/A, KA324/A: 3V-32V (or $\pm 1.5 \sim 15V$)
KA2902: 3V-26V (or $\pm 1.5V \sim 13V$)
- Input common-mode voltage range includes ground
- Large output voltage swing: 0V DC to $V_{CC} - 1.5V$ DC
- Power drain suitable for battery operation.

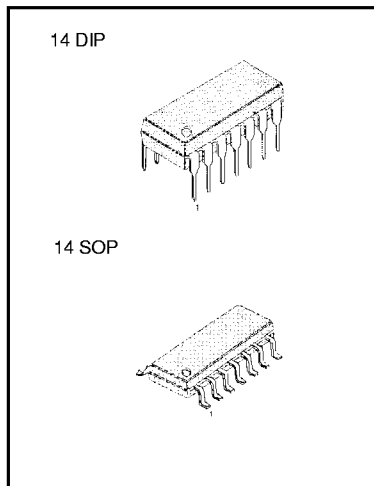

BLOCK DIAGRAM

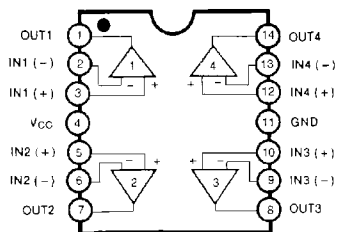

ORDERING INFORMATION

Device	Package	Operating Temperature
KA324 KA324A	14 DIP	0 ~ +70 °C
KA324D KA324AD	14 SOP	
KA224 KA224A	14 DIP	-25 ~ +85 °C
KA224D KA224AD	14 SOP	
KA2902	14 DIP	-40 ~ +85 °C
KA2902D	14 SOP	

SCHEMATIC DIAGRAM (One Section Only)

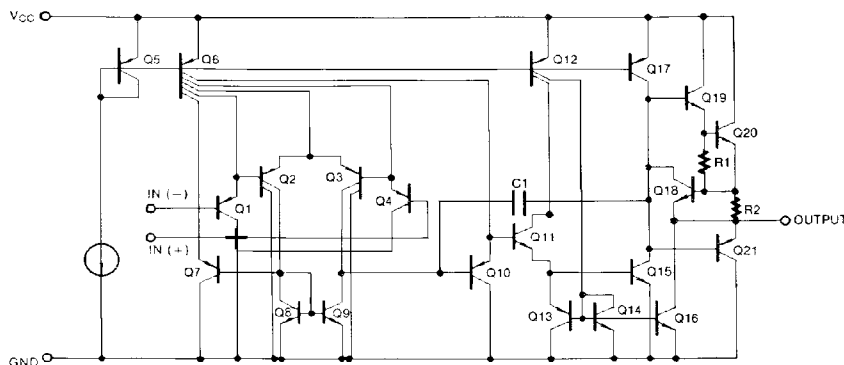

ABSOLUTE MAXIMUM RATINGS

Characteristic	Symbol	KA224/KA224A	KA324/KA324A	KA2902	Unit
Power Supply Voltage	V_{CC}	± 18 or 32	± 18 or 32	± 13 or 26	V
Differential Input Voltage	$V_{I(DIFF)}$	32	32	26	V
Input Voltage	V_I	-0.3 to +32	-0.3 to +32	-0.3 to +26	V
Output Short Circuit to GND $V_{CC} \leq 15V, T_A = 25^\circ C$ (One Amp)		Continuous	Continuous	Continuous	
Power Dissipation	P_D	570	570	570	mW
Operating Temperature Range	T_{OPR}	-25 ~ +85	0 ~ +70	-40 ~ +85	$^\circ C$
Storage Temperature Range	T_{STG}	-65 ~ +150	-65 ~ +150	-65 ~ +150	$^\circ C$

ELECTRICAL CHARACTERISTICS

($V_{CC} = 5.0V$, $V_{EE} = GND$, $T_A = 25^\circ C$, unless otherwise specified)

Characteristic	Symbol	Test Conditions	KA224			KA324			KA2902			Unit
			Min	Typ	Max	Min	Typ	Max	Min	Typ	Max	
Input Offset Voltage	V_{IO}	$V_{CM} = 0V$ to $V_{CC} = 1.5V$ $V_{O(P)} = 1.4V$, $R_S = 0\Omega$		1.5	5.0		1.5	7.0		1.5	7.0	mV
Input Offset Current	I_{IO}			2.0	30		3.0	50		3.0	50	nA
Input Bias Current	I_{BIAS}			40	150		40	250		40	250	nA
Input Common-Mode Voltage Range	$V_{I(R)}$	$V_{CC} = 30V$ ($V_{CC} = 26V$ for KA2902)	0		V_{CC} -1.5	0	V_{CC} -1.5		0		V_{CC} -1.5	V
Supply Current	I_{CC}	$R_L = \infty$, $V_{CC} = 30V$ (all Amps)		1.0	3		1.0	3		1.0	3	mA
		$R_L = \infty$, $V_{CC} = 5V$ (all Amps) ($V_{CC} = 26V$ for KA2902)		0.7	1.2		0.7	1.2		0.7	1.2	mA
Large Signal Voltage Gain	G_V	$V_{CC} = 15V$, $R_L \geq 2K\Omega$ $V_{O(P)} = 1V$ to 11V	50	100		25	100			100		V/mV
Output Voltage Swing	$V_{O(H)}$	$V_{CC} = 30V$ $R_L = 2K\Omega$	26			26			22			V
		$V_{CC} = 26V$ for 2902 $R_L = 10K\Omega$	27	28		27	28		23	24		V
	$V_{O(L)}$	$V_{CC} = 5V$, $R_L \geq 10K\Omega$		5	20		5	20		5	100	mV
Common-Mode Rejection Ratio	CMRR		70	85		65	75		50	75		dB
Power Supply Rejection Ratio	PSRR		65	100		65	100		50	100		dB
Channel Separation	CS	$f = 1KHz$ to 20KHz		120			120			120		dB
Short Circuit to GND	I_{SC}			40	60		40	60		40	60	mA
Output Current	I_{SOURCE}	$V_{I(+)} = 1V$, $V_{I(-)} = 0V$ $V_{CC} = 15V$, $V_{O(P)} = 2V$	20	40		20	40		20	40		mA
		$V_{I(+)} = 0V$, $V_{I(-)} = 1V$ $V_{CC} = 15V$, $V_{O(P)} = 2V$	10	13		10	13		10	13		mA
	I_{SINK}	$V_{I(+)} = 0V$, $V_{I(-)} = 1V$ $V_{CC} = 15V$, $V_{O(R)} = 200mV$	12	45		12	45					μA
Differential Input Voltage	$V_{I(DIFF)}$				V_{CC}			V_{CC}			V_{CC}	V

ELECTRICAL CHARACTERISTICS

($V_{CC} = 5.0V$, $V_{EE} = GND$, unless otherwise specified)

The following specification apply over the range of $-25^{\circ}C \leq T_A \leq +85^{\circ}C$ for the KA224; and the $0^{\circ}C \leq T_A \leq +70^{\circ}C$ for the KA324 ; and the $-40^{\circ}C \leq T_A \leq +85^{\circ}C$ for the KA2902

Characteristic	Symbol	Test Conditions	KA224			KA324			KA2902			Unit
			Min	Typ	Max	Min	Typ	Max	Min	Typ	Max	
Input Offset Voltage	V_{IO}	$V_{ICM} = 0V$ to $V_{CC} = 1.5V$ $V_{O(P)} = 1.4V$, $R_S = 0\Omega$			7.0			9.0			10.0	mV
Input Offset Voltage Drift	$\Delta V_{IO}/\Delta T$			7.0			7.0			7.0		$\mu V/^{\circ}C$
Input Offset Current	I_{IO}				100			150			200	nA
Input Offset Current Drift	$\Delta I_{IO}/\Delta T$			10			10			10		$pA/^{\circ}C$
Input Bias Current	I_{BIAS}				300			500			500	nA
Input Common-Mode Voltage Range	$V_{IC(R)}$	$V_{CC} = 30V$ ($V_{CC} = 26V$ for KA2902)	0		$V_{CC} - 2.0$	0		$V_{CC} - 2.0$	0		$V_{CC} - 2.0$	V
Large Signal Voltage Gain	G_V	$V_{CC} = 15V$, $R_L \geq 2.0K\Omega$ $V_{O(P)} = 1V$ to $11V$	25			15			15			V/mV
Output Voltage Swing	$V_{O(H)}$	$V_{CC} = 30V$ $V_{CC} = 26V$ for 2902	$R_L = 2K\Omega$ 26			26			22			V
	$V_{O(L)}$	$V_{CC} = 5V$, $R_L \geq 10K\Omega$		5	20		5	20		5	100	mV
Output Current	I_{SOURCE}	$V_{I(+)} = 1V$, $V_{I(-)} = 0V$ $V_{CC} = 15V$, $V_{O(P)} = 2V$	10	20		10	20		10	20		mA
	I_{SINK}	$V_{I(+)} = 0V$, $V_{I(-)} = 1V$ $V_{CC} = 15V$, $V_{O(P)} = 2V$	10	13		5	8		5	8		mA
Differential Input Voltage	$V_{I(DIFS)}$				V_{CC}			V_{CC}			V_{CC}	V

ELECTRICAL CHARACTERISTICS

(V_{CC}=50V, V_{EE} = GND, T_A=25°C, unless otherwise specified)

Characteristic	Symbol	Test Conditions	KA224A			KA324A			Unit
			Min	Typ	Max	Min	Typ	Max	
Input Offset Voltage	V _{IO}	V _{CM} = 0V to V _{CC} = 1.5V V _{O(P)} = 1.4V, R _S = 0		1.0	3.0		1.5	3.0	mV
Input Offset Current	I _{IO}			2	15		3.0	30	nA
Input Bias Current	I _{BIAS}			40	80		40	100	nA
Input Common-Mode Voltage Range	V _{I(R)}	V _{CC} = 30V	0		V _{CC} -1.5	0		V _{CC} -1.5	V
Supply Current (All Amps)	I _{CC}	V _{CC} = 30V		1.5	3		1.5	3	mA
		V _{CC} = 5V		0.7	1.2		0.7	1.2	mA
Large Signal Voltage Gain	G _V	V _{CC} = 15V, R _L ≥ 2KΩ V _{O(P)} = 1V to 11V	50	100		25	100		V/mV
Output Voltage Swing	V _{O(H)}	V _{CC} = 30V R _L = 2KΩ	26			26			V
		V _{CC} = 26V for 2902 R _L = 10KΩ	27	28		27	28		V
	V _{O(L)}	V _{CC} = 5V, R _L ≥ 10KΩ		5	20		5	20	mV
Common-Mode Rejection Ratio	CMRR		70	85		65	85		dB
Power Supply Rejection Ratio	PSRR		65	100		65	100		dB
Channel Separation	CS	f = 1KHz to 20KHz		120		120			dB
Short Circuit to GND	I _{SC}			40	60		40	60	mA
Output Current	I _{SOURCE}	V _{I(+)} = 1V, V _{I(-)} = 0V V _{CC} = 15V	20	40		20	40		mA
		V _{I(+)} = 0V, V _{I(-)} = 1V V _{CC} = 15V, V _{O(P)} = 2V	10	20		10	20		mA
	I _{SINK}	V _{I(+)} = 0V, V _{I(-)} = 1V V _{CC} = 15V, V _{O(P)} = 200mV	12	50		12	50		μ A
Differential Input Voltage	V _{I(DIFF)}				V _{CC}			V _{CC}	V

ELECTRICAL CHARACTERISTICS

(V_{CC} = 5.0V, V_{EE} = GND, unless otherwise specified)The following specifications apply over the range of -25°C ≤ T_A ≤ +85°C for the KA224A; and the 0°C ≤ T_A ≤ +70°C for the KA324A

Characteristic	Symbol	Test Conditions	KA224A			KA324A			Unit
			Min	Typ	Max	Min	Typ	Max	
Input Offset Voltage	V _{IO}	V _{CM} = 0V to V _{CC} = 1.5V V _{O(P)} = 1.4V, R _S = 0Ω			4.0			5.0	mV
Input Offset Voltage Drift	Δ V _{IO} /Δ T			7.0	20		7.0	30	μ V/°C
Input Offset Current	I _{IO}				30			75	nA
Input Offset Current Drift	Δ I _{IO} /Δ T			10	200		10	300	pA/°C
Input Bias Current	I _{BIAS}			40	100		40	200	nA
Input Common-Mode Voltage Range	V _{I(R)}	V _{CC} = 30V	0		V _{CC} -2.0	0		V _{CC} -2.0	V
Large Signal Voltage Gain	G _V	V _{CC} = 15V, R _L ≥ 2.0KΩ	25			15			V/mV
Output Voltage Swing	V _{O(P,P)}	V _{CC} = 30V	R _L = 2KΩ	26			26		V
			R _L = 10KΩ	27	28		27	28	
		V _{CC} = 5V, R _L ≤ 10KΩ		5	20		5	20	mA
Output Current	I _{SOURCE}	V _{I(+)} = 1V, V _{I(-)} = 0V V _{CC} = 15V	10	20		10	20		mA
	I _{SINK}	V _{I(+)} = 0V, V _{I(-)} = 1V V _{CC} = 15V	5	8		5	8		mA
Differential Input Voltage	V _{I(DIFF)}				V _{CC}			V _{CC}	V

TYPICAL PERFORMANCE CHARACTERISTICS

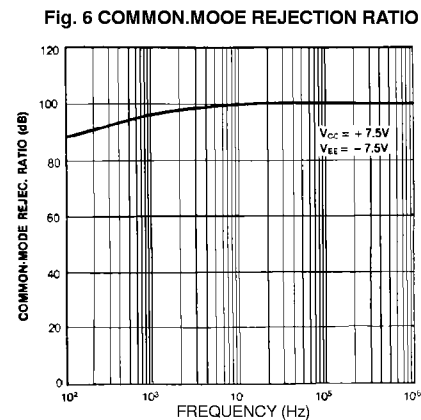
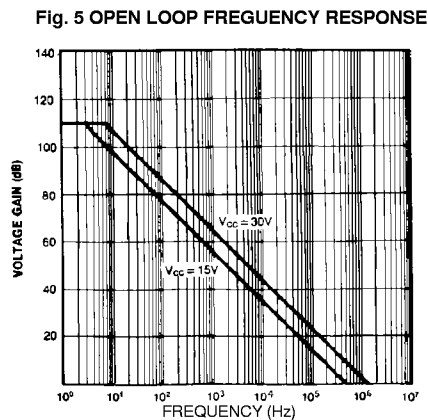
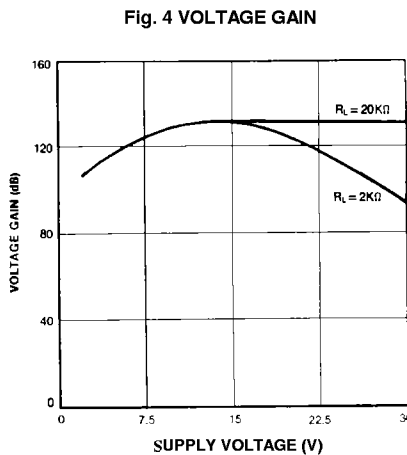
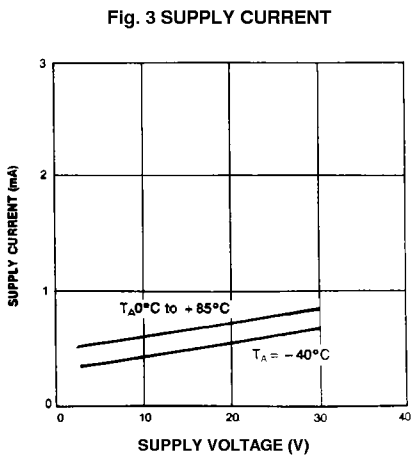
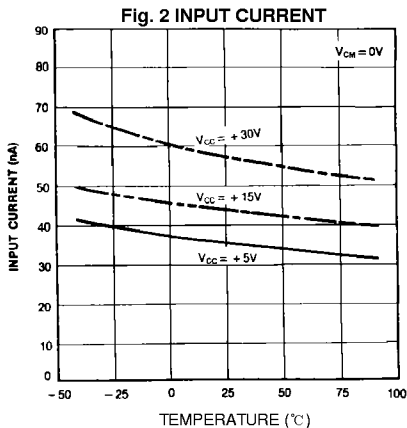
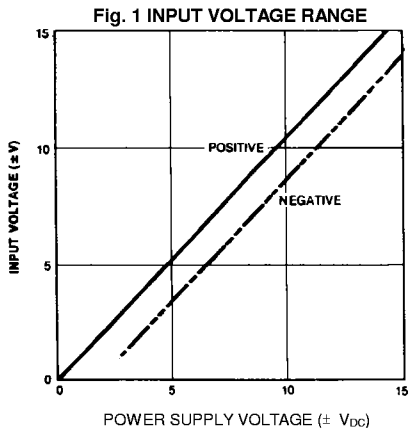

Fig. 7 SLEW RATE

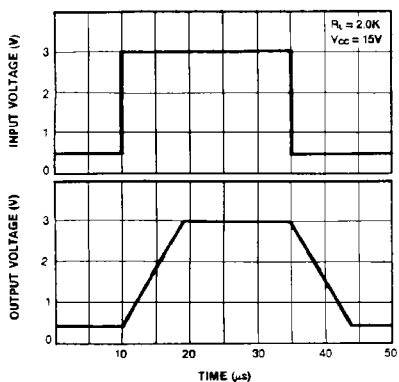

Fig. 8 VOLTAGE FOLLOWER PULSE RESPONSE (SMALL SIGNAL)

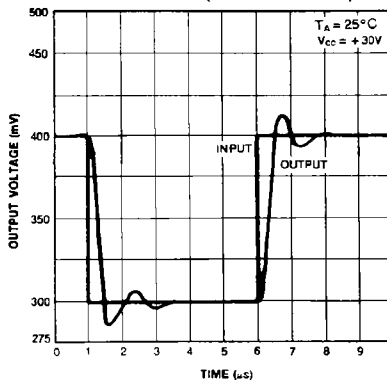

Fig. 9 LARGE SIGNAL FREQUENCY RESPONSE

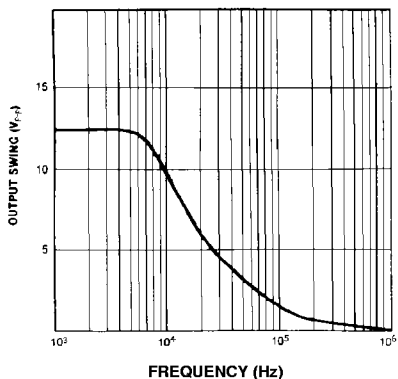

Fig. 10 OUTPUT CHARACTERISTICS CURRENT SOURCING

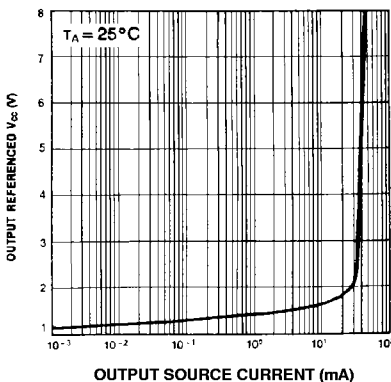

Fig. 11 OUTPUT CHARACTERISTICS CURRENT SINKING

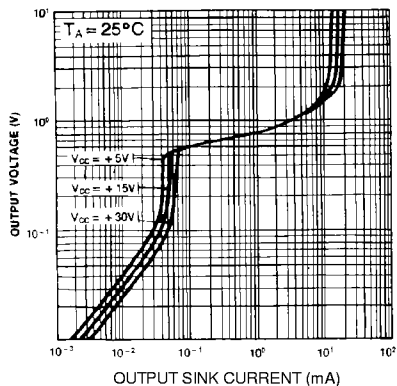

Fig. 12 CURRENT LIMITING

