

May 1999

## Virtual Ground Analog Switch

### Features

- Switches Analog Signals - Interfaces with Most Integrated Logic
- Switching Speeds Less Than 0.5µs
- I<sub>D(OFF)</sub> Less Than 500pA Typical at 70°C
- Effective r<sub>DS(ON)</sub> - 5Ω to 50Ω
- Commercial and Military Temperature Range Operation

**OBSOLETE PRODUCT  
NO RECOMMENDED REPLACEMENT**  
Call Central Applications 1-800-442-7747  
or email: centapp@harris.com

### Description

The IH5009 series of analog switches were designed to fill the need for an easy-to-use, inexpensive switch for both industrial and military applications. Although low cost is a primary design objective, performance and versatility have not been sacrificed.

Each package contains up to four channels of analog gating and is designed to eliminate the need for an external driver. The odd numbered devices are designed to be driven directly from TTL open collector logic (15 volts) while the even numbered devices are driven directly from low level TTL logic (5 volts). Each channel simulates a SPDT switch. SPST switch action is obtained by leaving the diode cathode unconnected; for SPDT action, the cathode should be grounded (0V). The parts are intended for high performance multiplexing and commutating usage. A logic "0" turns the channel ON and a logic "1" turns the channel OFF.

### Part Number Information

PART NUMBER	CHANNELS	LOGIC LEVEL	PACKAGE	PKG NO.
IH5009	4	+15	DD, PD	
IH5010	4	+5	DD, PD	
IH5011	4	+15	DE, PE	
IH5012	4	+5	DE, PE	
IH5014	3	+5	DD, PD	
IH5016	3	+5	DE, PE	
IH5017	2	+15	PA	
IH5018	2	+5	DD, PA	
IH5019	2	+15	DE, PA	
IH5020	2	+5	DE, PA	
IH5022	1	+5	DD, PA	
IH5024	1	+5	PA	

NOTE: Mil-Temperature range (-55°C to 125°C) available in ceramic packages only.

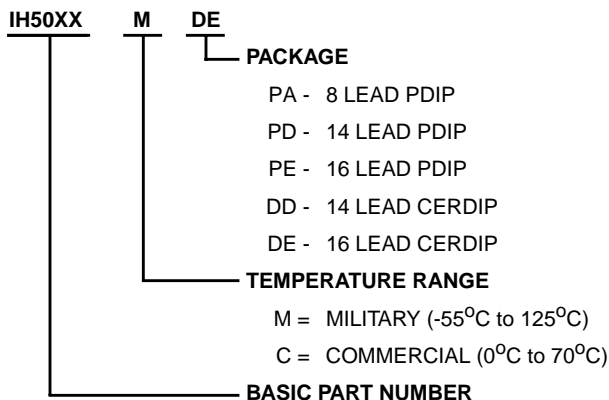

# IH5009 Series

## Functional Diagrams (Numbers in brackets refer to Cerdip Packages)

**IH5009, IH5010**  
(14 LEAD CERDIP, 14 LEAD PDIP)

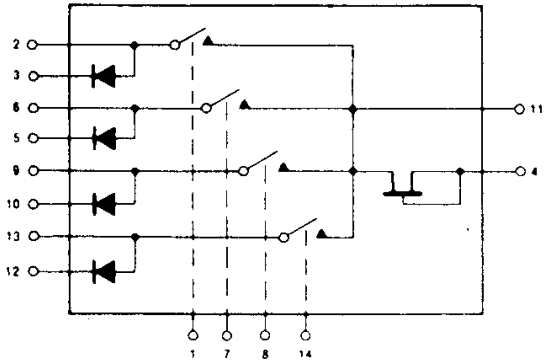

**IH5011, IH5012**  
(16 LEAD CERDIP, 16 LEAD PDIP)

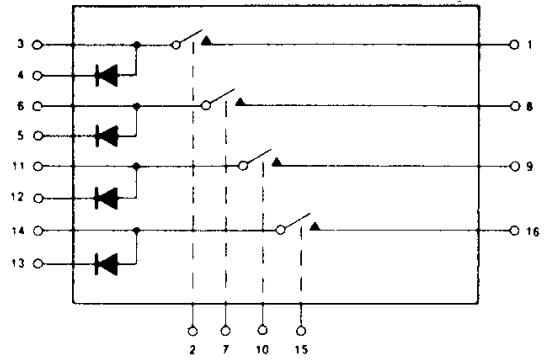

**IH5014**  
(14 LEAD CERDIP, 14 LEAD PDIP)

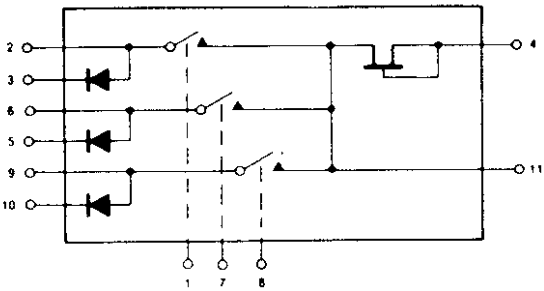

**IH5016**  
(16 LEAD CERDIP, 16 LEAD PDIP)

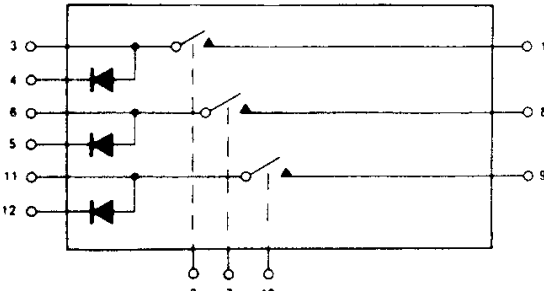

**IH5017 (8 LEAD PDIP)**  
**IH5018 (8 LEAD PDIP, 14 LEAD CERDIP)**

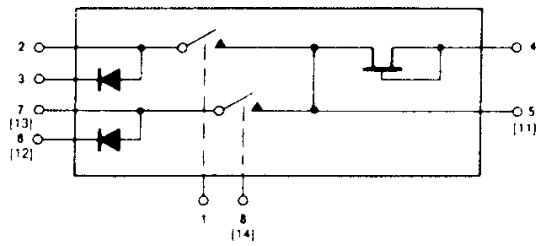

**IH5019, IH5020**  
(8 LEAD PDIP, 16 LEAD CERDIP)

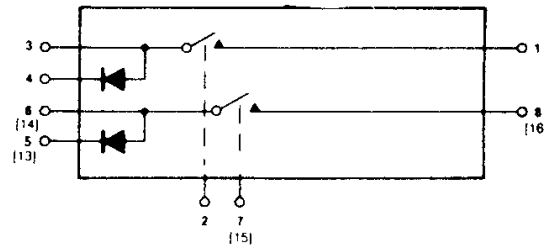

**IH5022**  
(8 LEAD PDIP, 14 LEAD CERDIP)

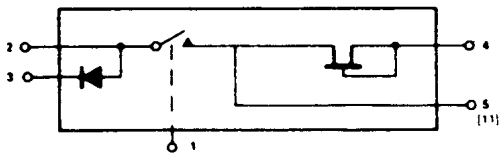

**IH5024**  
(8 LEAD PDIP)

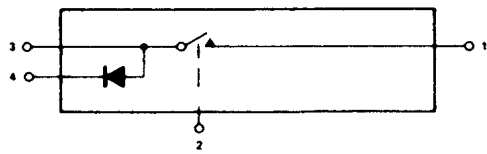

## IH5009 Series

### Absolute Maximum Ratings

Positive Analog Signal Voltage	30V
Negative Analog Signal Voltage	-15V
Diode Current	10mA
Power Dissipation (Note)	500mW

### Thermal Information

Maximum Storage Temperature Range	-65°C to 150°C
Maximum Lead Temperature (Soldering 10s)	300°C

### Operating Conditions

Temperature Range

5009C Series	0°C to 70°C
5009M Series	-55°C to 125°C

*CAUTION: Stresses above those listed in "Absolute Maximum Ratings" may cause permanent damage to the device. This is a stress only rating and operation of the device at these or any other conditions above those indicated in the operational sections of this specification is not implied.*

NOTE: Dissipation rating assumes device is mounted with all leads welded or soldered to printed circuit board in ambient temperature below 75°C. For higher temperature, derate at rate of 5m/W°C.

### Electrical Specifications (Per Channel)

PARAMETER	(NOTE 1) SYMBOL	(NOTE 4) TEST CONDITIONS	(NOTE 2) TYPE	-55°C (M) 0°C (C) MIN/MAX	25°C		125°C (M) 70°C (C) MIN/MAX	UNITS
					TYP	MIN/MAX		
Input Current-ON	I <sub>IN(ON)</sub>	ALL	V <sub>IN</sub> = 0V, I <sub>D</sub> = 2mA	-	0.01	±0.5	100	μA
Input Current-OFF	I <sub>IN(OFF)</sub>	5V Logic Ckts	V <sub>IN</sub> = +4.5V, V <sub>A</sub> = ±10V	-	0.04	±0.5	20	nA
Input Current-OFF	I <sub>IN(OFF)</sub>	15V Logic Ckts	V <sub>IN</sub> = +11V, V <sub>A</sub> = ±10V	-	0.04	±0.5	20	nA
Channel Control Voltage-ON	V <sub>IN(ON)</sub>	5V Logic Ckts	Note 3	0.5	-	0.5	0.5	V
Channel Control Voltage-ON	V <sub>IN(ON)</sub>	15V Logic Ckts	Note 3	1.5	-	1.5	1.5	V
Channel Control Voltage-OFF	V <sub>IN(OFF)</sub>	5V Logic Ckts	Note 3	-	-	4.5	4.5	V
Channel Control Voltage-OFF	V <sub>IN(OFF)</sub>	15V Logic Ckts	Note 3	-	-	11.0	11.0	V
Leakage Current-OFF	I <sub>D(OFF)</sub>	5V Logic Ckts	V <sub>IN</sub> = +4.5V, V <sub>A</sub> = ±10V	-	0.02	±0.5	20	nA
Leakage Current-OFF	I <sub>D(OFF)</sub>	15V Logic Ckts	V <sub>IN</sub> = +11V, V <sub>A</sub> = ±10V	-	0.02	±0.5	20	nA
Leakage Current-ON	I <sub>D(ON)</sub>	5V Logic Ckts	V <sub>IN</sub> = 0V, I <sub>S</sub> = 1mA	-	0.30	±1.0	1000 (M) 200 (C)	nA
Leakage Current-ON	I <sub>D(ON)</sub>	15V Logic Ckts	V <sub>IN</sub> = 0V, I <sub>S</sub> = 1mA	-	0.10	±0.5	500 (M) 100 (C)	nA
Leakage Current-ON	I <sub>D(ON)</sub>	5V Logic Ckts	V <sub>IN</sub> = 0V, I <sub>S</sub> = 2mA	-	-	1.0	10	μA
Leakage Current-ON	I <sub>D(ON)</sub>	15V Logic Ckts	V <sub>IN</sub> = 0V, I <sub>S</sub> = 2mA	-	-	2.0	100	μA
Drain-Source ON-Resistance	r <sub>DS(ON)</sub>	5V Logic Ckts	I <sub>D</sub> = 2mA, V <sub>IN</sub> = 0.5V	150	90	150	385 (M) 240 (C)	Ω
Drain-Source ON-Resistance	r <sub>DS(ON)</sub>	15V Logic Ckts	I <sub>D</sub> = 2mA, V <sub>IN</sub> = 1.5V	100	80	100	250 (M) 160 (C)	Ω
Turn-ON Time	t <sub>(ON)</sub>	All		-	150	500	-	ns
Turn-OFF Time	t <sub>(OFF)</sub>	All		-	300	500	-	ns
Cross Talk	CT	All	f = 100Hz	-	120	-	-	dB

NOTES:

- (OFF) and (ON) subscript notation refers to the conduction state of the FET switch for the given test.
- Refer to Figure 1 for definition of terms.
- V<sub>IN(ON)</sub> and V<sub>IN(OFF)</sub> are test conditions guaranteed by the tests of r<sub>DS(ON)</sub> and I<sub>D(OFF)</sub> respectively.
- "5V Logic CKTS" applies to even-numbered devices. "15V Logic CKTS" applies to odd-numbered devices.